

• SUPPLEMENTAL INSTRUCTIONS FOR THE USER
 • COMPLÉMENTAIRES INSTRUCTIONS POUR L'UTILISATEUR

DIRECTION OF ROTATION
 DIRECTION DE ROTATION

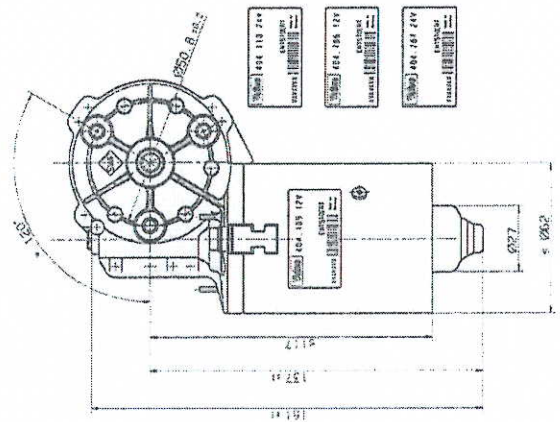

SCHALTPLAN
 CIRCUIT DIAGRAM

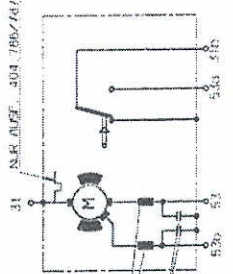

LEISTUNGSREIHE
 PERFORMANCE RANGE

U _N	I _N	P _N	n _n
24V	1.3A	32 W	1425 min ⁻¹
12V	2.6A	64 W	1425 min ⁻¹
24V	2.6A	64 W	1425 min ⁻¹
12V	5.2A	128 W	1425 min ⁻¹

PRESENZ AU 5-POLEIGEN FACHSTRECK-
 AUSSTEUERUNGSKABEL. 2334
 TO BE USED WITH 5-POL TERMINAL BLOCK
 AS-NO. 2334 FROM REISSBACH

NO. 6 WIRKLEISE
 FASE 1 - 0 5 N25
 PH. 6 (PHILIPPS)
 CHAPER 1 - 0 5 A45

FLACHTREIBER 2-BAD. B. DIN 46244
 RALE SPACE TERMINAL 2-BAD. B. DIN 46244

DECKELFESTLEGEN: VORLEISTUNG
 COVER INSTALLATION: PRE-LOADING
 COUVERTEMENT: AVANT MONTAGE
 CAPOTAGE

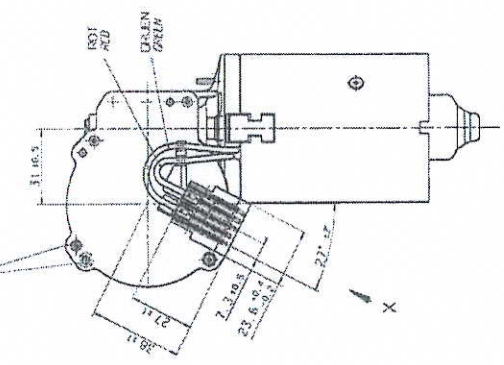

WELLENSCHUTZ
 SHAFT PROTECTION
 DIN 72 783

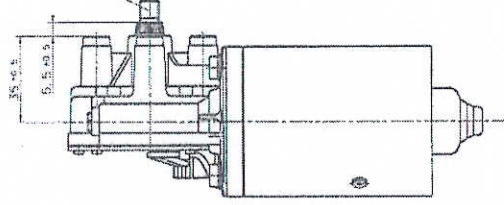

X 2:1

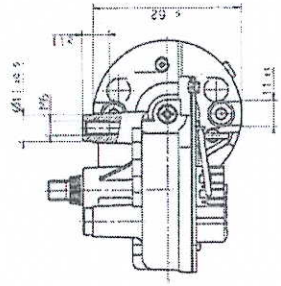
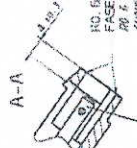
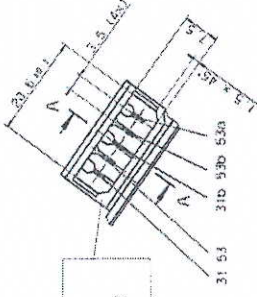

Part No.	Part Name	QTY	Unit
404 110 210	Motor	1	EA
404 110 110	Motor	1	EA
404 105 110	Motor	1	EA
404 105 210	Motor	1	EA

Part No.	Part Name	QTY	Unit
404 110 210	Motor	1	EA
404 110 110	Motor	1	EA
404 105 110	Motor	1	EA
404 105 210	Motor	1	EA

Part No.	Part Name	QTY	Unit
404 110 210	Motor	1	EA
404 110 110	Motor	1	EA
404 105 110	Motor	1	EA
404 105 210	Motor	1	EA

Part No.	Part Name	QTY	Unit
404 110 210	Motor	1	EA
404 110 110	Motor	1	EA
404 105 110	Motor	1	EA
404 105 210	Motor	1	EA

Part No.	Part Name	QTY	Unit
404 110 210	Motor	1	EA
404 110 110	Motor	1	EA
404 105 110	Motor	1	EA
404 105 210	Motor	1	EA

Part No.	Part Name	QTY	Unit
404 110 210	Motor	1	EA
404 110 110	Motor	1	EA
404 105 110	Motor	1	EA
404 105 210	Motor	1	EA

Part No.	Part Name	QTY	Unit
404 110 210	Motor	1	EA
404 110 110	Motor	1	EA
404 105 110	Motor	1	EA
404 105 210	Motor	1	EA

Part No.	Part Name	QTY	Unit
404 110 210	Motor	1	EA
404 110 110	Motor	1	EA
404 105 110	Motor	1	EA
404 105 210	Motor	1	EA